

1/16" SQ. STRIPS

DIHEDRAL BLOCK

FLAP

A

POSITION OF LICENSE NUMERALS

# NC117

B

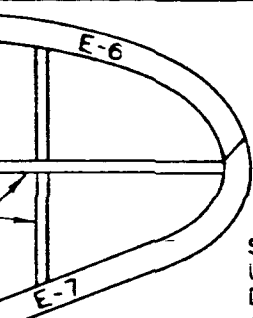

SUPPORTS PLACED UNDER TIPS WHEN DIHEDRAL BLOCKS ARE GLUED IN.

WING STRUT

FRONT VIEW  
1/2 SIZE

1-1/2" LONG

2-7/8"

GLUE IN PLACE AFTER THE WINDSHIELD COWL IS ON

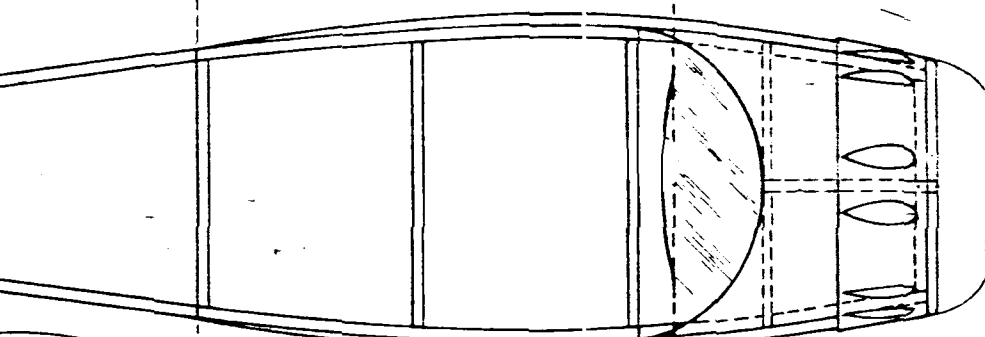

GLUE WINDSHIELD ON AFTER WING IS IN PLACE

COLOR STRIPE

GLUE, CO  
BUMPS ON  
STRIP

WINDSHIELD PATT

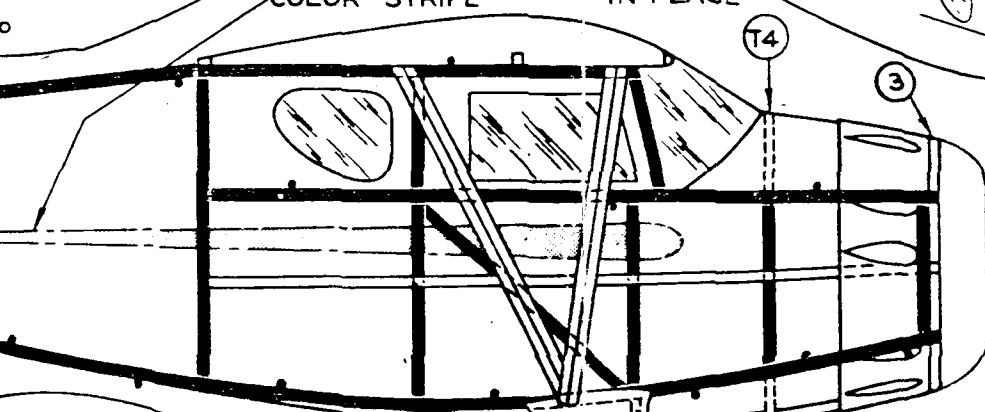

ROUND NOSE-BLOCK AFTER GLUING TO FORMER 3.

GLUE 1/16" SQ STRIP THEN BUILD WING S THIS PATTERN.

GLUE LANDING STRUT TO LINE ON INSIDE PANT COVER

COVERS

1-1/2"

CORES

OUTSIDE PANT COVER

PIN

TOP VIEW OF PANT

WINGS  
DRAWN

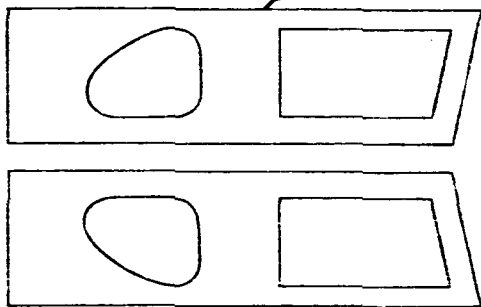
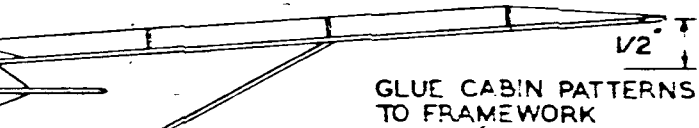
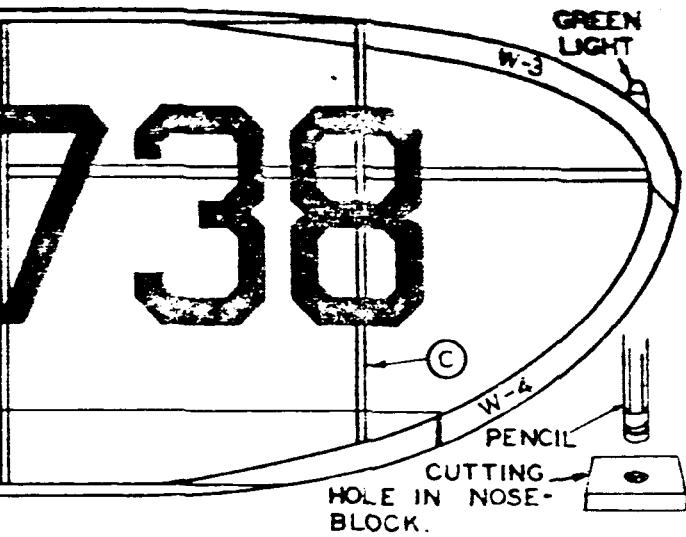

AFTER THE COWL IS ON

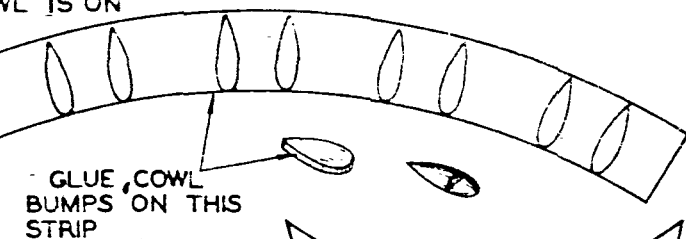

WINDSHIELD PATTERN



1/16" SQ. STRIPS TOGETHER. BUILD WING STRUTS OVER PATTERN.



WINGSPAN 16" | LENGTH 10"

DRAWN BY *[Signature]* | KIT NO. A27

