

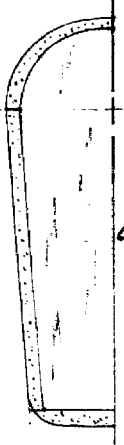

1

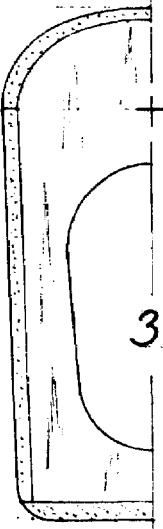

2



3

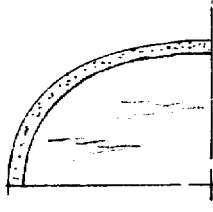

4

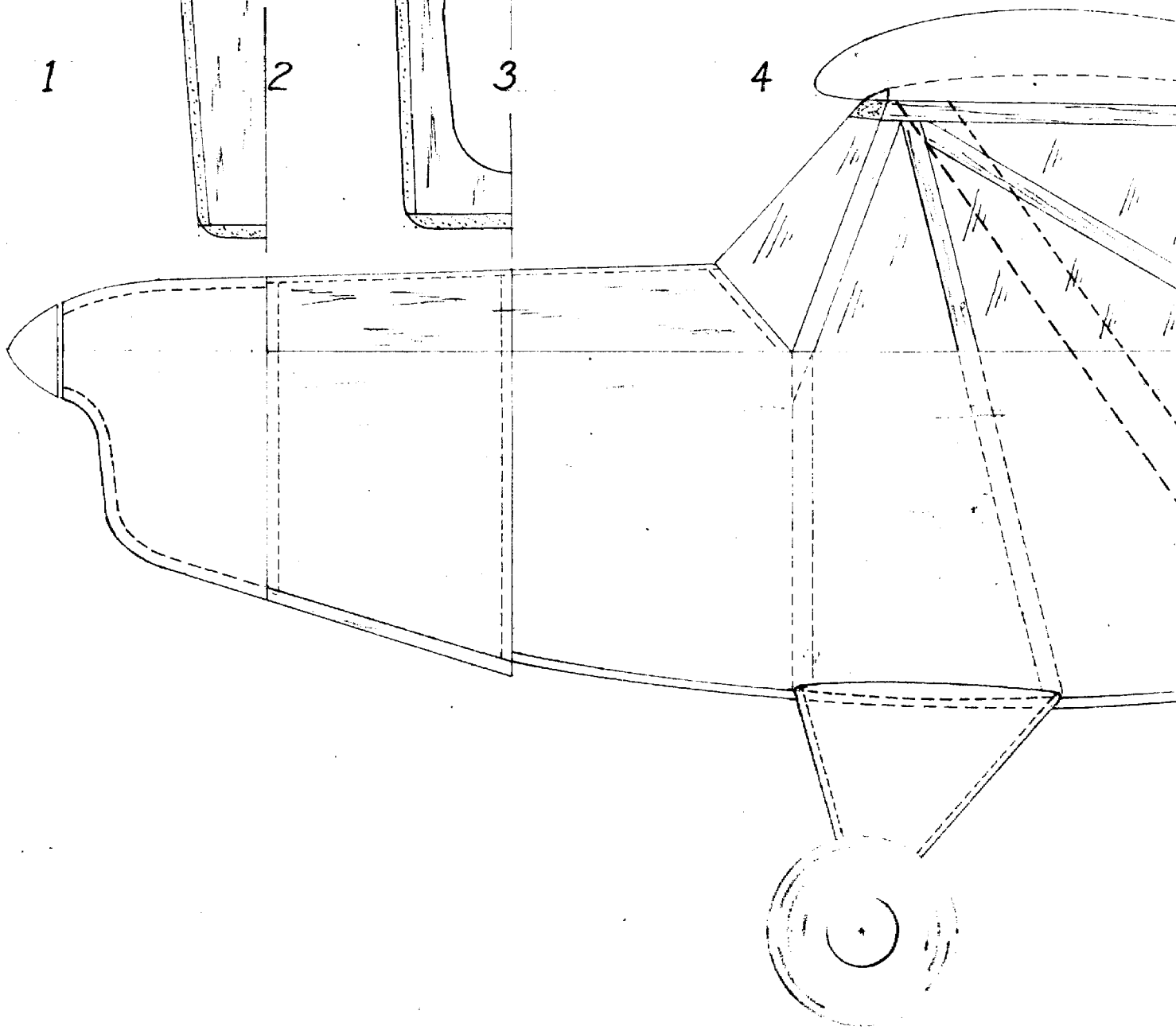

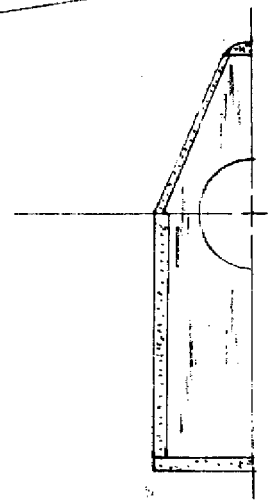
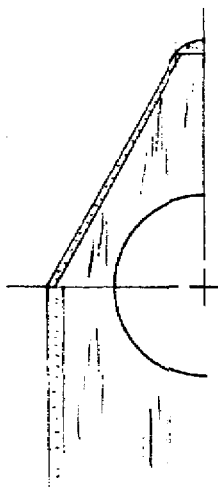
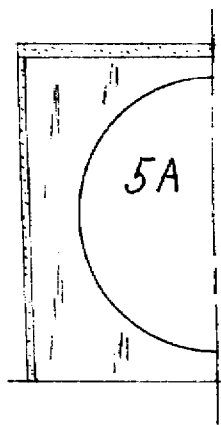
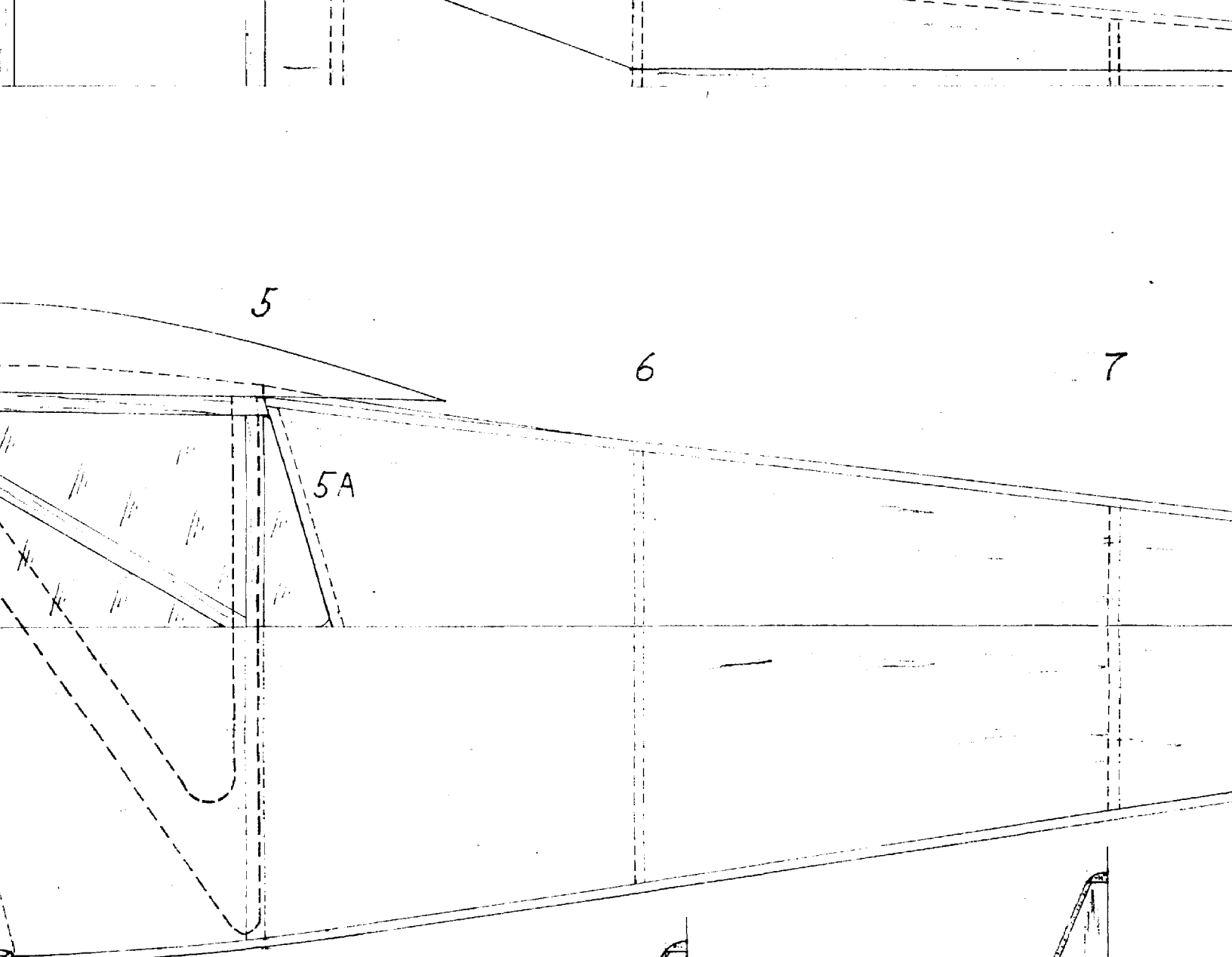

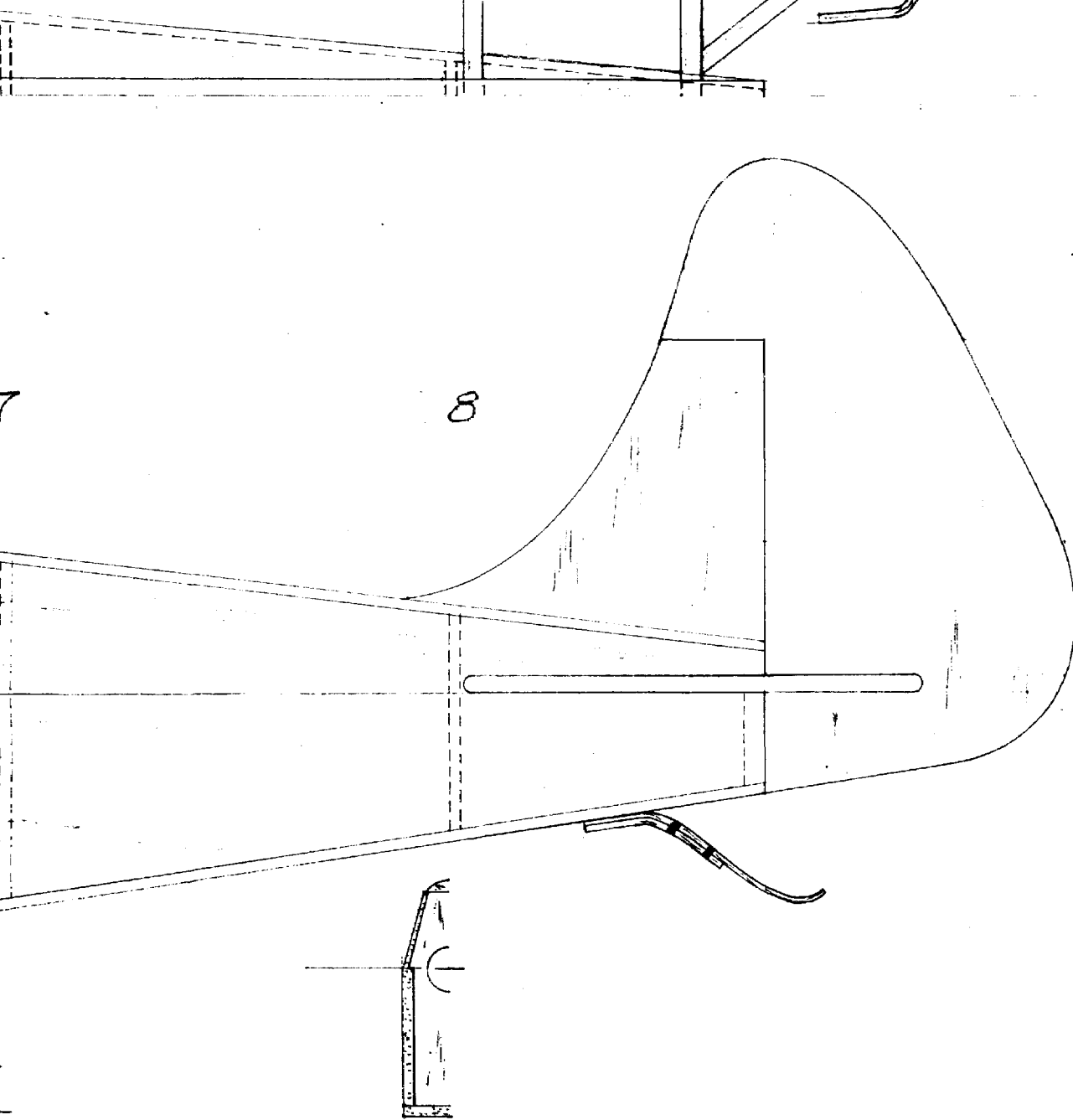

LUTON "MAJOR" (FREE FLT.)

31 3/4" SPAN, .020 ENGINE (SPORT AVIATION-SEPT.'65)

H.G. BOWERS, CHARLESTON, OCT.'65