

WING PANEL

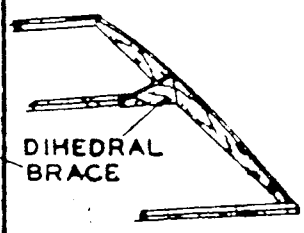

COLOR SCHEME
 BODY-DARK BLUE
 WING, ELEVATOR, AND RUDDER-LIGHT BLUE.

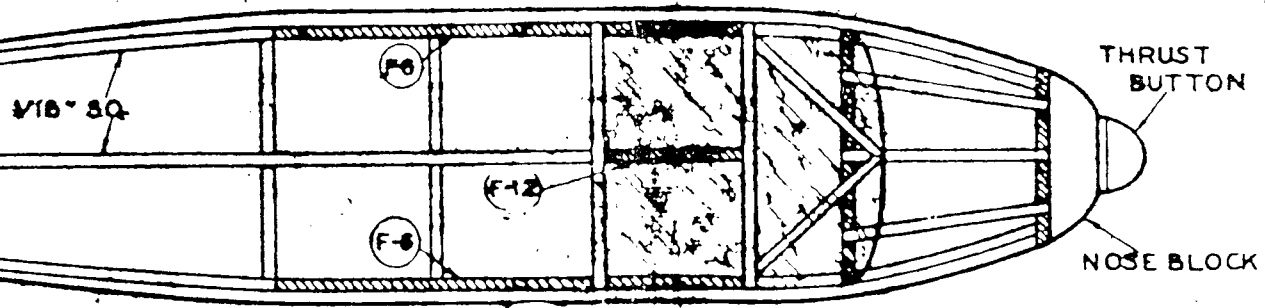
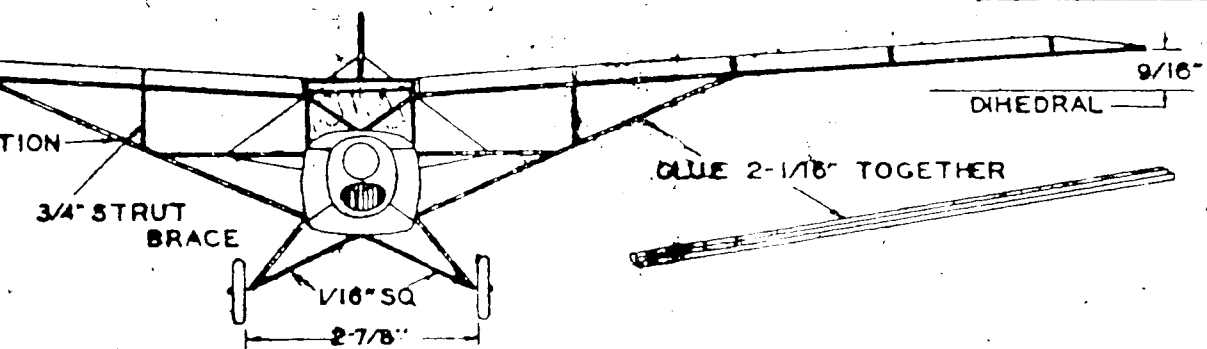
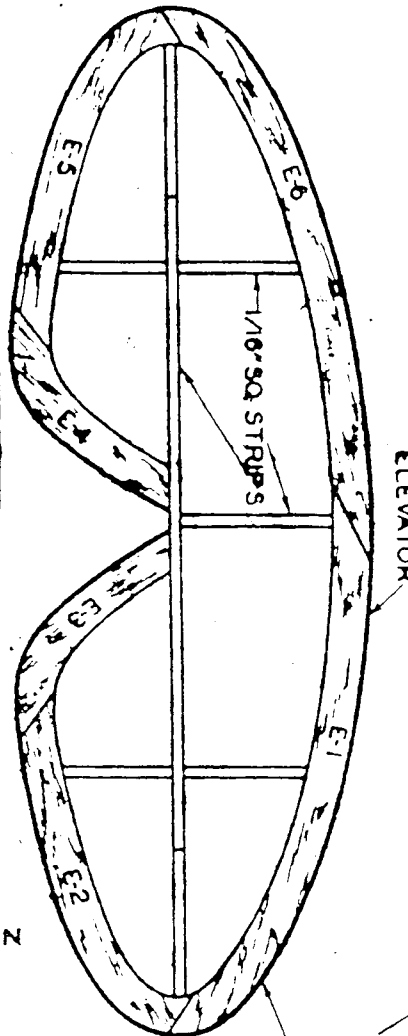

TOP VIEW

RUBBER BEFORE COVER-MODEL

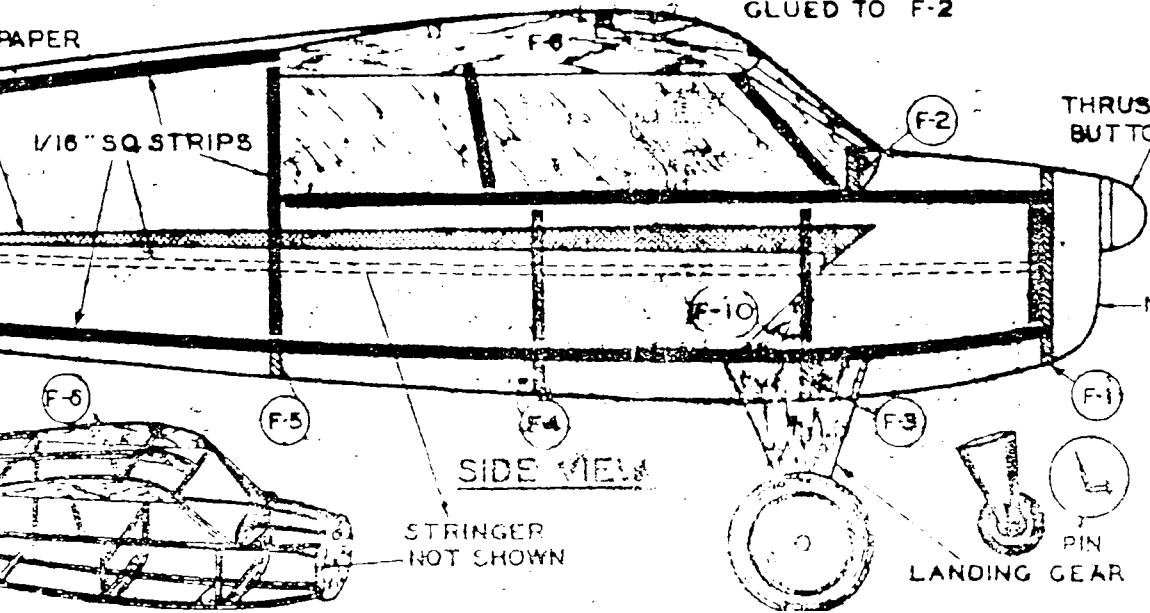

SIDE VIEW

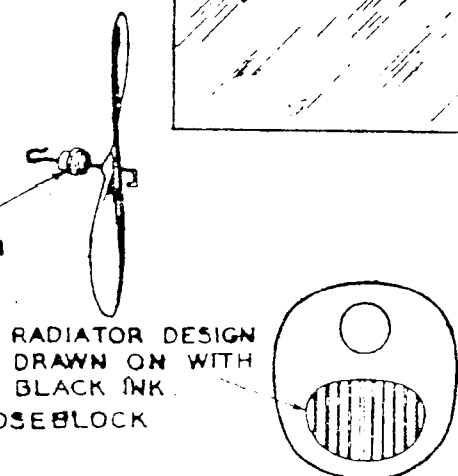

AKRON FUNK

WINGSPAN 20" | LENGTH

DRAWN BY

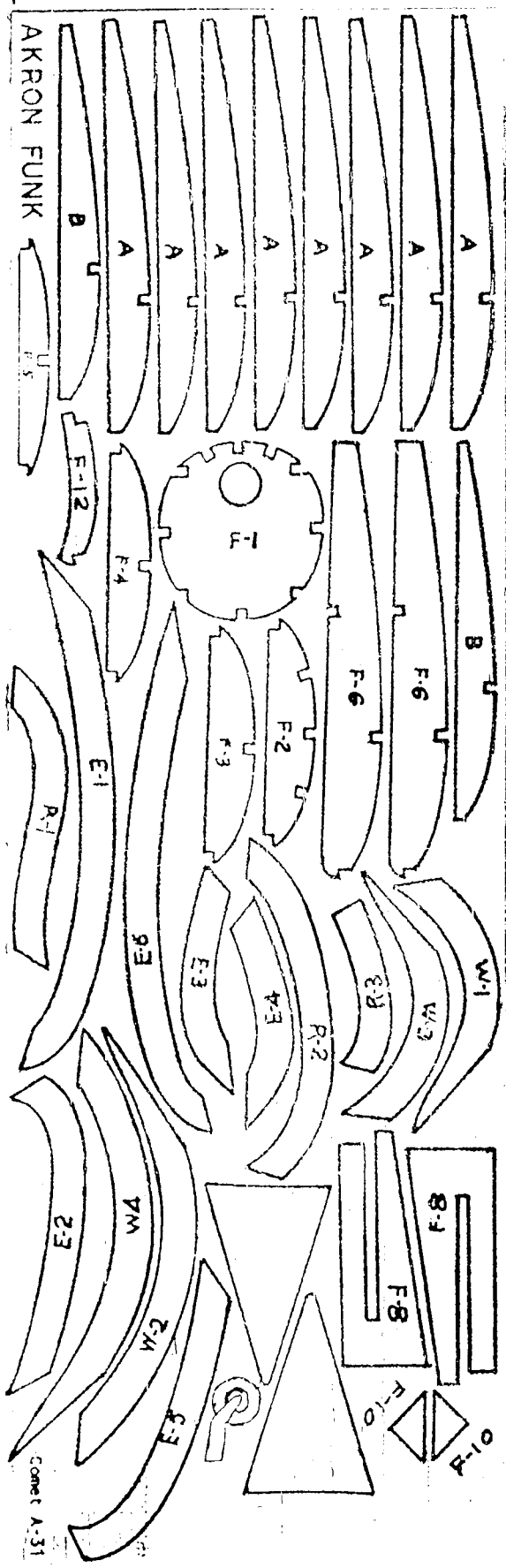

Comet A-31

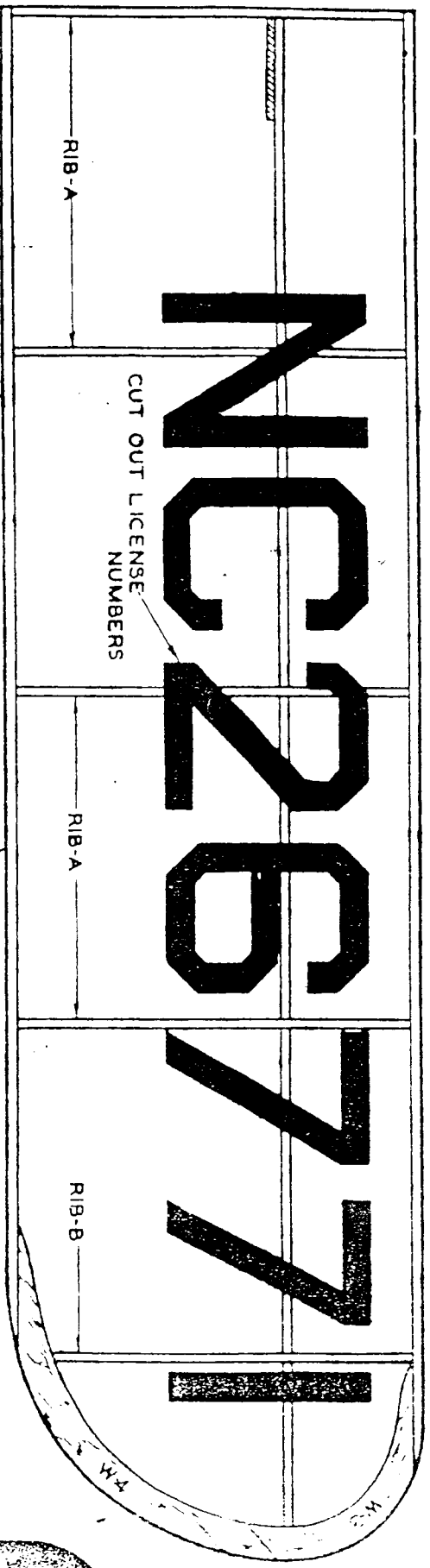

WING PANEL

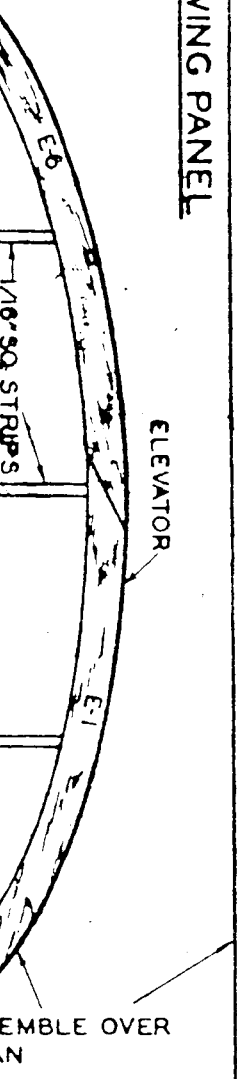

ASSEMBLE OVER

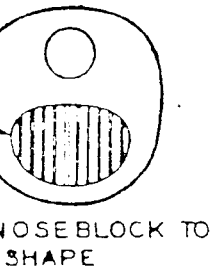

NOSEBLOCK TO SHAPE

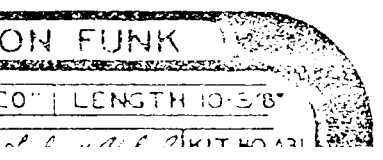

LENGTH 10-5/8"