

FOKKER C-14

DRAWINGS
FULL SIZE

RIB 1-3 REQ (1/16" SHEET, ALL OTHERS
1/32" SHEET)

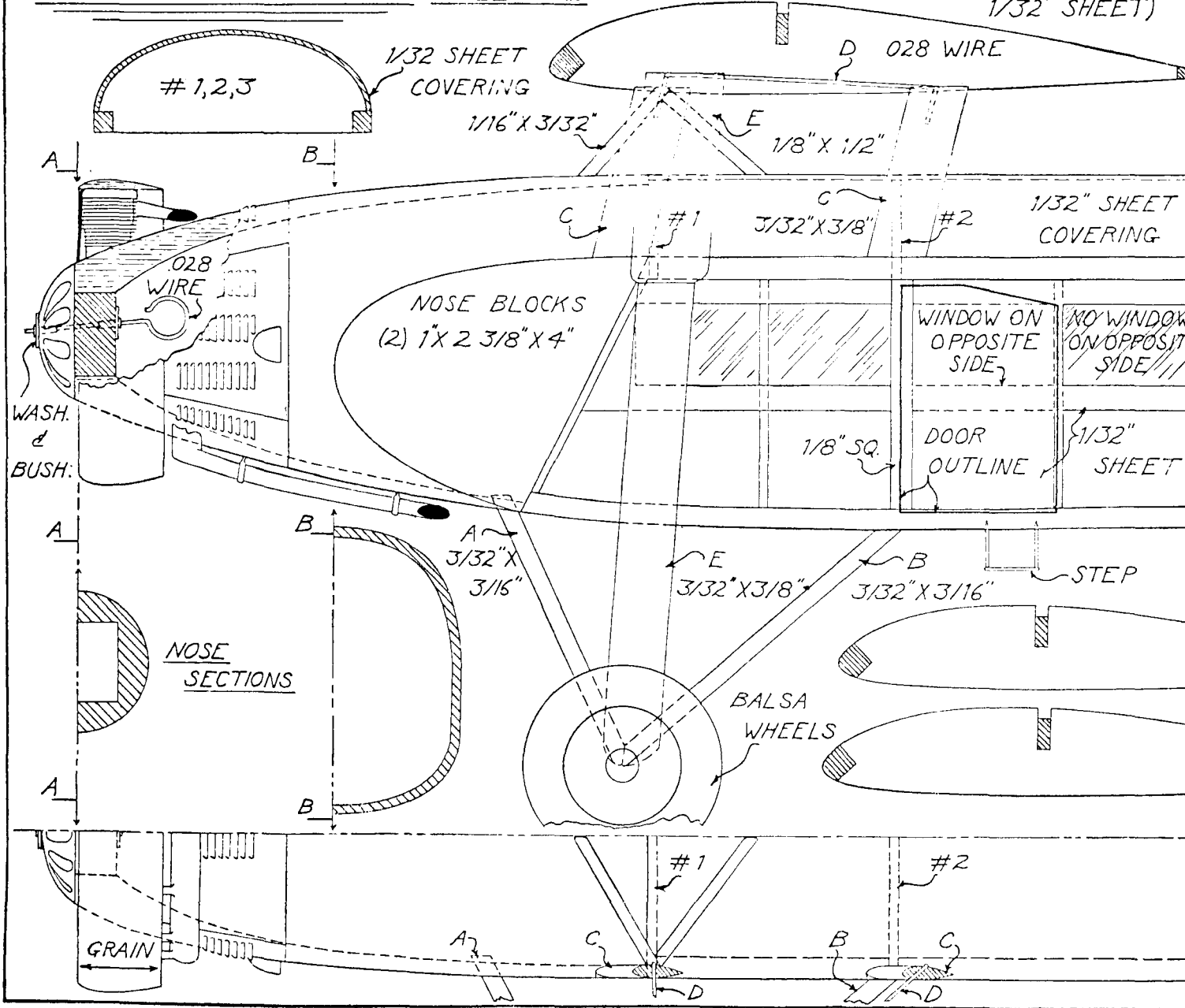

OTHERS
SHEET)

PLATE I

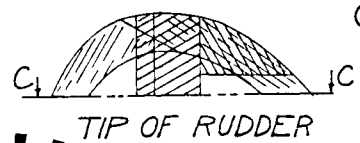
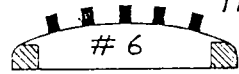
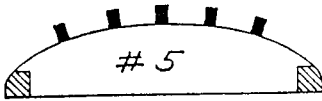
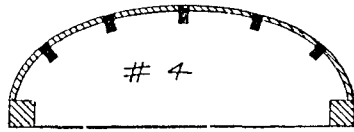

ALL FORMERS 1/16" SHEET

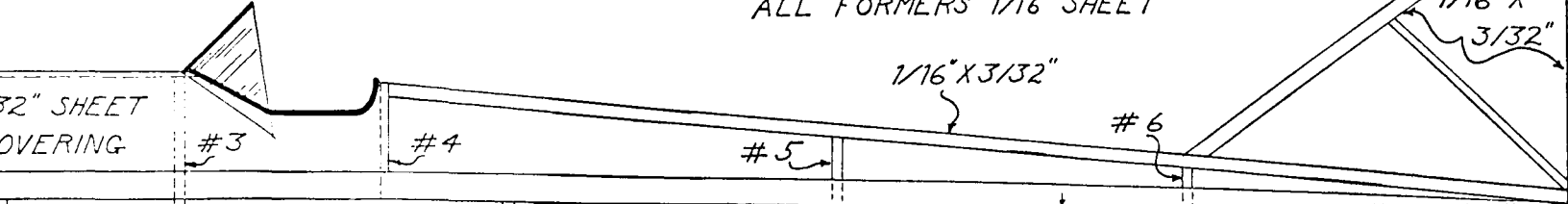

NO WINDOW
ON OPPOSITE
SIDE

RED CROSS

U.S. ARMY
FOK. Y-10-15
A.C. 35885

1/16" NEGATIVE
INCIDENCE

Z 1/16"
SHEET

.028
WIRE

UPRIGHTS
1/16" X 1/8"

LONGERONS
1/8" SQ.

014
WIRE
EDGING

TAIL WHEEL
1/16" SHEET

-STEP

ENTIRE AIRPLANE-
WHITE

RIB 7-2 REQ.

RIB 3-2 REQ.

RIB 6-2 REQ.

RIB 2-2 REQ.

RIB 4-2 REQ.

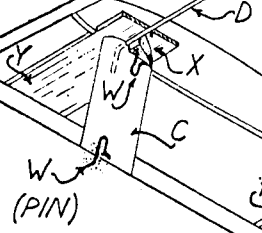

WING MOUNT
DETAIL

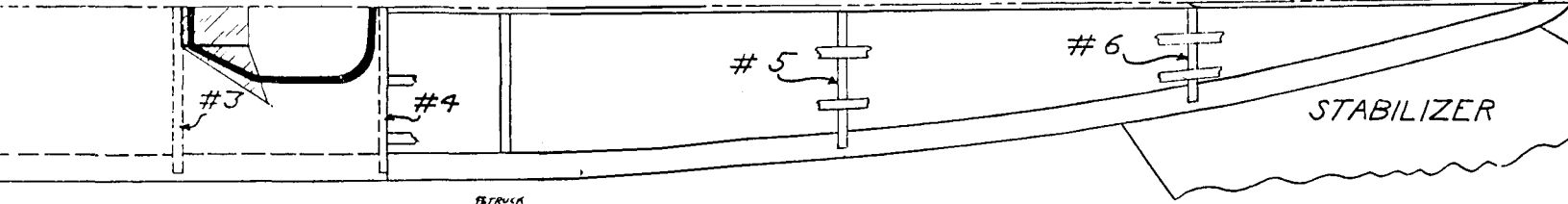

BRUCK

PLATE III

LEADING EDGE 1/8" SQ.

SPAR 1/16" X 3/16"

RIB 3

RIB 4

RIB 5

RIB 6

RIB 7

RIB 8

TRAILING EDGE 1/16" X 1/4"

OP. BLOCK 7/8" X 1 1/4" X 6 1/2"

1/16" X 3/32"

1/16" SHEET

1/16" SQ.

1/16" X 1/8"

1/16" SHEET

TIP OF WING

ESTRICK

