

WINDSHIELD BRACES
CEMENTED IN PLACE

ELEVATOR
CONTROL
CABLE

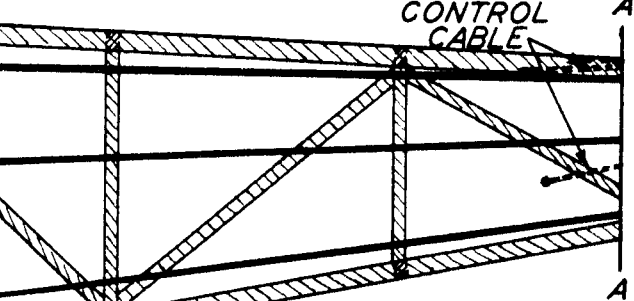

MINUM
RE

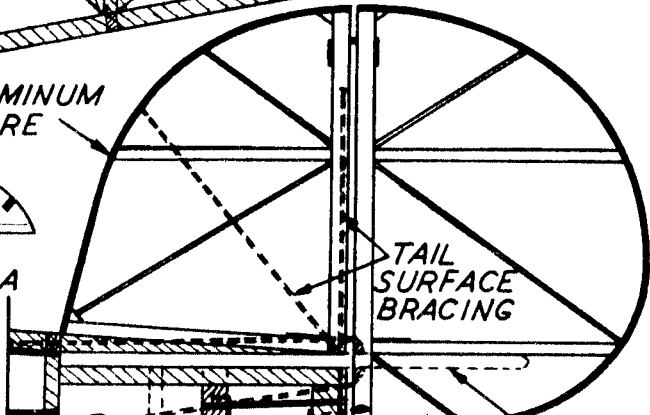

STABILIZER
POSITION

PIANO WIRE
TAIL SKID

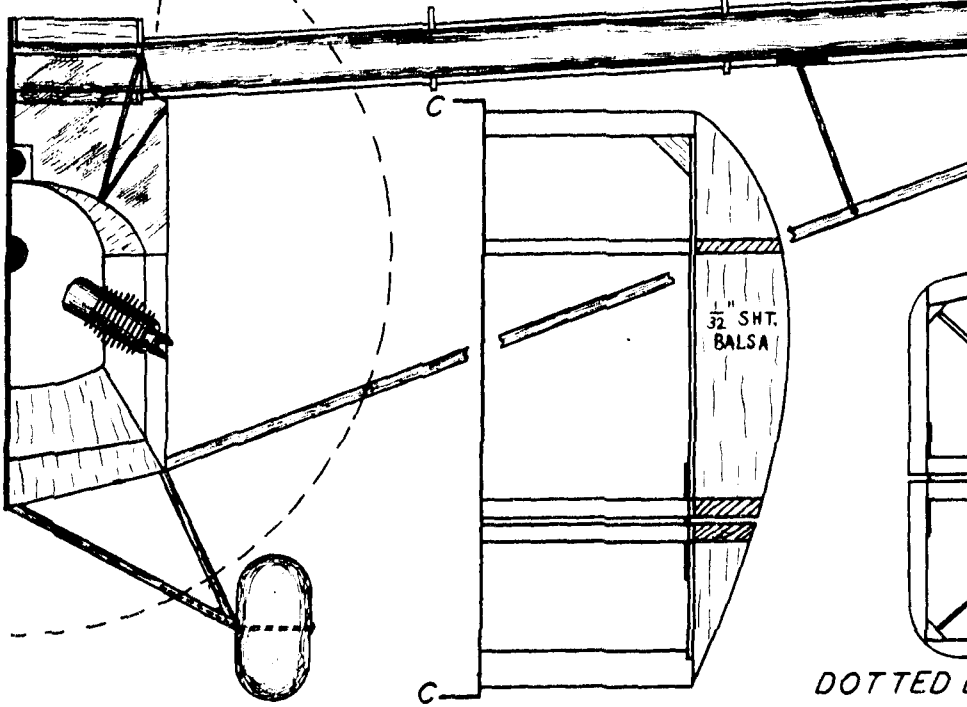
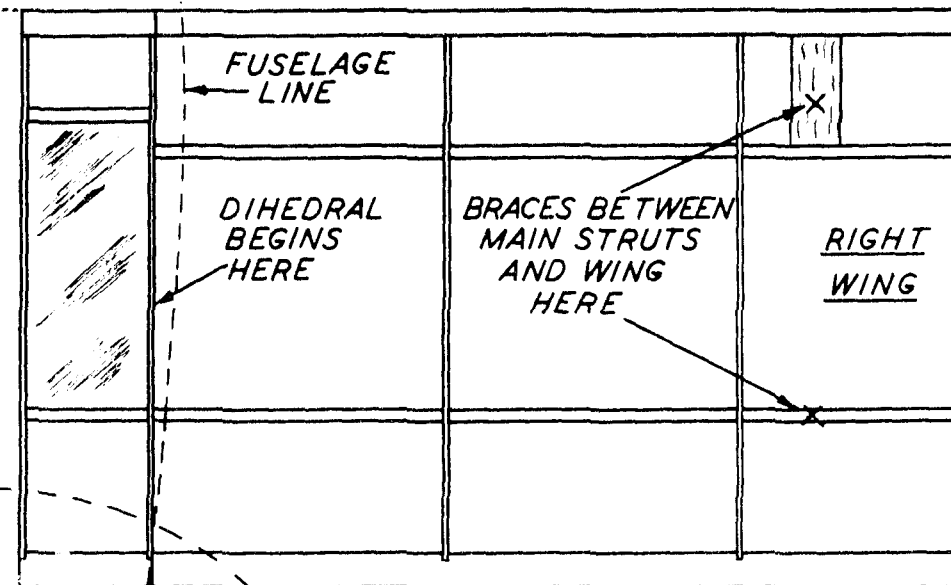
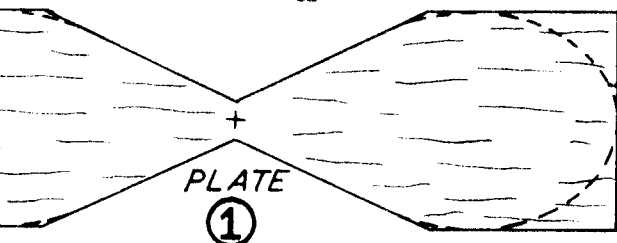
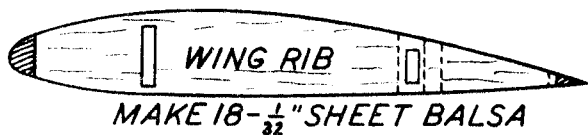

DOTTED

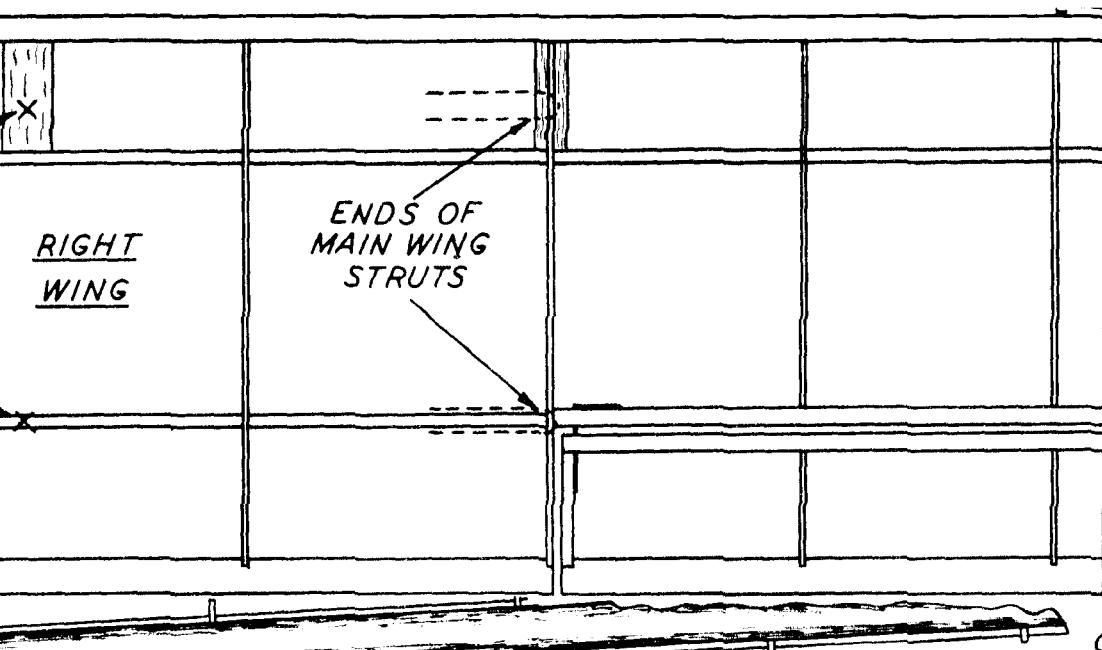

RIGHT
WING

ENDS OF
MAIN WING
STRUTS

WING DIHEDRAL ~ $\frac{1}{2}''$ AT TIP

SCALE OF MODEL
 $\frac{1}{80}$ FULL SIZE

PLATE

②

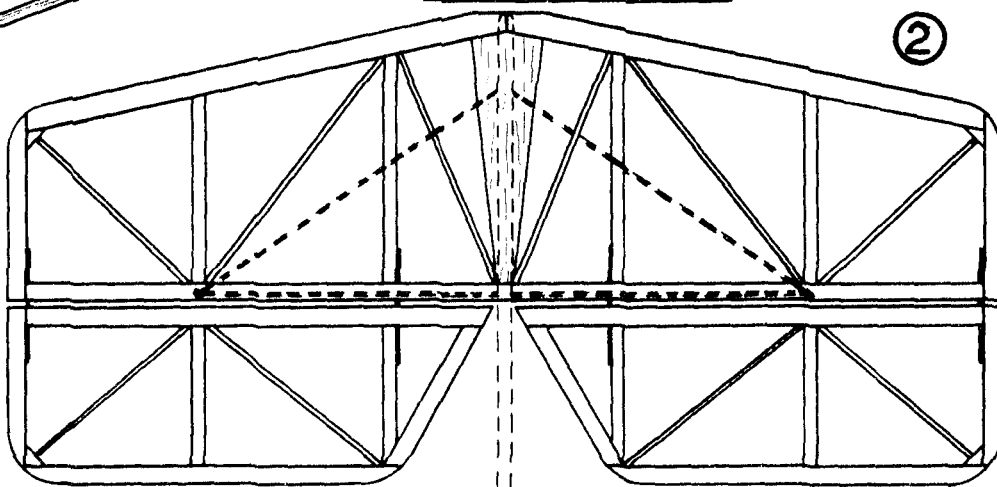

DOTTED LINES ON STABILIZER INDICATE RUDDER & BRACE WIRE POS.